

DCM230 DC Energy Meter



- Measures kWh, W, V, A etc.
- Bi-directional measurement IMP & EXP
- Pulse output
- RS485 Modbus
- Din rail mounting 35mm
- DC shunt connection
- Class 1

User Manual V2.0

Introduction

Eastron DCM230-2 series DC energy meters are designed for measuring and monitoring in DC systems. The din rail DC energy meters can measure of important DC parameters: Voltage, current, power and energy etc. It also support bi-directional measurement with pulse output. All data in the meter are accessible via RS485 using Modbus RTU. The meter works with DC power supply. Input voltage range up to 1000V DC, and current inputs are flexible with DC shunt.

PART 1 Specification

Model list

Model	Shunt	Voltage Range	Current Range	Pulse Constant(Default)
DCM230-2-150	150A/75mv	100V-1000V	7.5-150 (180) A	100 imp/kwh
DCM230-2-200	200A/75mv		10-200 (240) A	100 imp/kwh
DCM230-2-300	300A/75mv		15-300 (360) A	10 imp/kwh
DCM230-2-400	400A/75mv		20-400 (480) A	10 imp/kwh
DCM230-2-600	600A/75mv		30-600 (720) A	10 imp/kwh
DCM230-2-800	800A/75mv		40-800 (960) A	10 imp/kwh

General Specifications

Voltage DC Input:	Min.100V DC, Max. 1000V DC
Auxiliary Supply:	Min. 9V DC, Max. 40V DC
DC Shunt Input:	75mV (default) 60mV, 45mV (optional)
Current Range:	0~2000A
Power consumption:	≤ 1W
AC voltage withstand:	4400V/ 1min
Impulse voltage withstand:	6.4kV - 1.2/50μS waveform
Pulse output:	1, 10, 100, 1000 imp/kWh (default)
Pulse duration:	60, 100 (default), 200mS
Pulse output indicate:	Total kWh/ import kWh/ export kWh
Display:	LCD with backlit

Max. Reading:	999999.9999kWh
Weight:	220g
Standard:	GB/T 33708-2017/ IEC62053-41

Unit Characteristics

The Unit can measure and display:

- voltage
- Currents
- Power
- Active energy imported and exported

Pulse output indicates real-time energy measurement. An RS485 output allows remote monitoring from another display or a computer.

Shunt Primary Current

The unit can be configured to operate with primary current and secondary input.

Primary current range: up to 2000A

Second input: 75mV in default, 45mV, 60mV optional

RS485 Output for Modbus RTU

For Modbus RTU, the following RS485 communication parameters can be configured from the Set-up menu:

Baud rate 1200,2400, 4800, 9600,19200 bps

Parity none (default)/odd/even

Stop bits 1 or 2

RS485 network address *nnn* – 3-digit number, 001 to 247

Modbus™ Word order Hi/Lo byte order is set automatically to normal or reverse. It cannot be configured from the set-up menu.

Set-up screens are provided for setting up the RS485 port.

Pulse output

The unit provides a pulse output. The constant can be configured to below:

1000 imp/kwh

100 imp/kWh

10 imp/kWh

1 imp/kWh

Pulse width: 200/100(default)/60 ms.

Note: the relationship between pulse constant and CT1

Zhejiang Eastron Electronic Co.,Ltd. Tel: 0086-573-83698881 Fax: 0086-573-83698883
Address: No.52 Dongjin Road, Nanhu, Jiaxing, Zhejiang, China. Web: www.eastron.com.cn email: sales@eastrongroup.com

CT1 setting	Default pulse constant	Settable pulse constant
1 – 20	1000 imp/kWh	1000,100,10,1 imp/kWh
21 – 200	100 imp/kWh	100,10,1 imp/kWh
201 – 2000	10 imp/kWh	10,1 imp/kWh

*when the CT setting on meter is 2000A, the default pulse constant is 10 imp/kWh and it can be set to 10 imp/kWh or 1 imp/kWh.

*Over-current alarm: Alarm will happened when the current is over the CT1 value set on the meter. The Alarm LED will stay solid and the corresponding register value will be changed. The user can read this register through communication to determine whether an overcurrent alarm has occurred.

The pulse outputs can be set to generate pulses to represent Import kWh/ Export kWh/ total kWh.

The pulse output is passive type, complies with IEC62053-31 Class A.

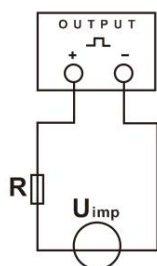

ATTENTION: Pulse output must be fed as shown in the wiring diagram below. Scrupulously respect polarities and the connection mode. Opto-coupler with potential-free SPST-NO Contact. Contact range:5~27VDC Max. current Input:27mA DC.

Environment

Operating temperature	-30 °C to + 60°C
Reference temperature	23°C ± 2°C
Relative humidity	0 to 90%, non-condensing
Altitude	up to 2000m
Installation category	CATIII
Mechanical Environment	M1
Electromagnetic environment	E2
Degree of pollution	2

Mechanics

Din rail dimensions	36x100x63 (WxHxD) DIN 43880
Mounting	DIN rail 35mm
Ingress Protection	IP51 (indoor)
Material	Self-extinguishing UL94V-0

PART 2 Operation

Initialization Display

When it is powered on, the meter will initialize and do self-checking.

	<p>Full Screen (stay 2s)</p>
	<p>Software Version (stay 2s) (This information is for reference only, in kind pervail.)</p>
	<p>Current Modbus address (stay 2s)</p>

	<p>Current baud rate (stay 2s)</p>
	<p>Total active energy(kWh) Total=Import+ Export Max read: 999999.9999 kWh</p>

Buttons function

There are two buttons on the front panel.

	<p>>Scroll the display for data checking. >Changing option at Set-up mode >Exit the Set-up mode</p>
	<p>>Set-up mode entry >Confirmation</p>

Scroll display

After initialization and self-checking program, the meter displays the measured values. The default page is total kWh. If the user wants to check other information, please press the scroll button  on the front panel.

	<p>Total active energy(kWh)</p> <p>Total=Import+ Export</p> <p>Display format:</p> <p>6+4</p> <p>999999.9999 -> 000000.0000</p>
	<p>Partial resettable active energy</p> <p>Display format:</p> <p>6+4</p> <p>999999.9999 -> 000000.0000</p>
	<p>Voltage</p>
	<p>Current</p>

	<p>Power</p> <p>Display format:</p> <p><1000 W: XXX W</p> <p><1000kW: XXX.XXX kW</p> <p>For other value: XXXX.XX kW</p>
	<p>Pulse constant</p>
	<p>CT1 Primary current</p>
	<p>Meter address</p>

	Baud rate
	Parity
	Software Version











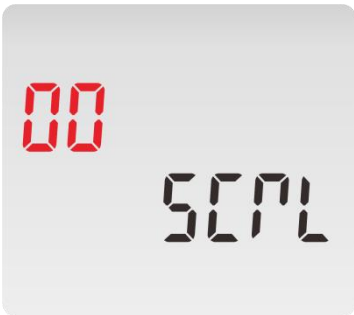



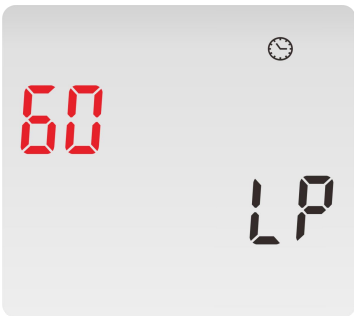



Set-up Mode

To get into Set-up Mode, the user need press the “Enter” button  for 3 second.

Page	Display	Descriptions
------	---------	--------------

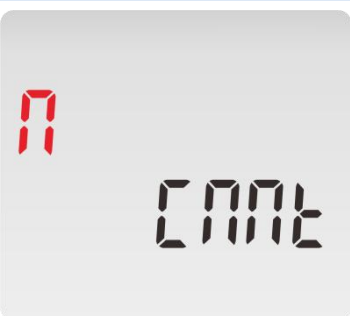
<p>1</p>		<p>Password</p> <p>To get into Set-up mode, it asks a password confirmation. Default password: 1000</p> <p>Use and to enter correct password.</p>
<p>2</p>		<p>Keep pressing for 3 second, the current selection will flash, use and to change the Modbus address. Options: 1~247</p> <p>Keep press for 3s to confirm the selection.</p>
<p>3</p>		<p>Keep pressing for 3 second, the current selection will flash, use and to change the Baud rate. Options: 1.2k, 2.4k,4.8k,9.6k (default),19.2k</p> <p>Keep press for 3s to confirm the selection.</p>
<p>4</p>		<p>Keep pressing for 3 second, the current selection will flash, use and to change the Parity. Options: EVEN,ODD,NONE (default)</p>
<p>5</p>		<p>Keep pressing for 3 second, the current selection will flash, use and to change the type of Pulse Output.</p> <p>Options: total kWh, IMP kWh, EXP kWh</p>

<p>6</p>		<p>Keep pressing for 3 second, the current selection will flash, use and to change the pulse constant.</p> <p>Options: 1000, 100, 10, 1 imp/kWh</p> <p>*Default pulse constant is related to the CT1 setting</p>
<p>7</p>		<p>Keep pressing for 3 second, the current selection will flash, use and to change the pulse width.</p> <p>Options: 60, 100, 200, unit: ms</p>
<p>8</p>		<p>Use to select the CT1 option. Keep pressing for 3 second, the current selection will flash, use and to enter the Primary current. The range is from 0001 to 2000. For example, if using a 100A/75mV current transformer, the CT1 shall be 0100.</p> <p>Keep press for 3s to confirm the selection.</p> <p>Deafult : 1A</p>
<p>9</p>		<p>Keep pressing for 3 second, the current selection will flash, use and to change the DIT(Demand Integration Time).</p> <p>Options: 0,5,8,10,15,20,30,60(default)</p>

10		<p>Use  to select the scroll display time option.</p> <p>Keep pressing  for 3 second, the current selection will flash, use  and  to enter the options: 0~60s.</p> <p>Default: 0 s, represent do not scroll display</p>
11		<p>Use  to select the backlit time option. Keep pressing  for 3 second, the current selection will flash, use  and  to enter the options: 0,5,10,20,30,60 minutes. 0 means the light is always on.</p> <p>Default: 60 minutes</p>
12		<p>Use  to select the Password option. Keep pressing  for 3 second, the current selection will flash, use  and  to enter the new password. The range is from 0001 to 9999.</p> <p>Default: 1000</p>
13		<p>Shunt wiring</p> <p>Use  to select the shunt connection option. Keep pressing  for 3 second, the current selection will flash, use  to choose the connection way.</p> <p>Option: N, P N: Negative type (default) P: Positive type</p>

Keep pressing button  to exit the set-up mold.

Wiring diagram

Terminal Connection

DC Power Supply:

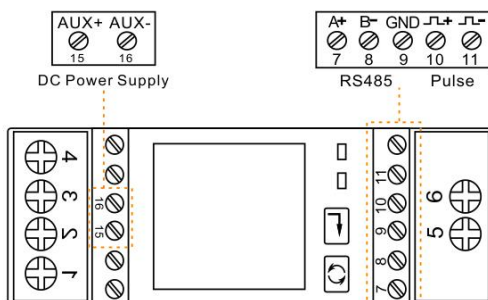

Shunt Connection

Positive Type:

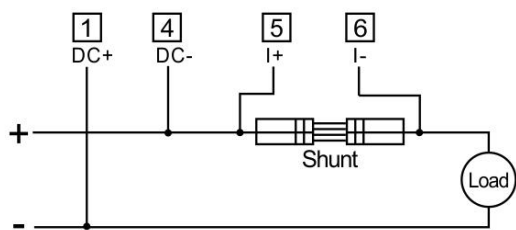

Shunt Connection: Positive Type

Negative Type:

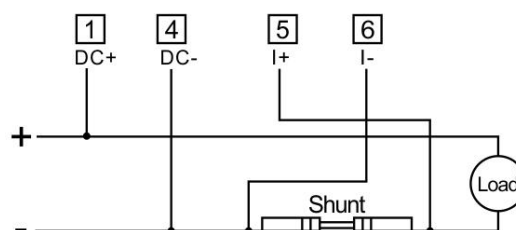



Shunt Connection: Negative Type

Terminals	Strip Length	Wire Range	Torque	Model
Aux. / RS485 / Pulse	5-6 mm	0.5-1.5mm ²	0.2Nm	PZ0
DC± / I ±	6-7 mm	0.5-2.5mm ²	0.2Nm	PZ0

Symbols

NO.	Symbol	Reference	Description
1	≡	IEC60417-5031(2002-10)	Direct current
2	~	IEC60417-5032(2002-10)	Alternating current

3		IEC60417-5172(2003-02)	Equipment protected throughout by DOUBLE INSULATION or REINFORCED INSULATION
4			Caution, possibility of electric shock
5		ISO 7000-0434b(2004-01)	Caution*

Warning

Warning



The General warning symbol calls attention to possible risks of injury. Observe all the instructions listed under the symbol to prevent injuries or even death.

Caution



This means hazard of electric shock and failure to take the necessary safety precautions will result in death, serious injury or considerable material damage.

- During normal operation, voltages hazardous to life may be present at some of the terminals of this unit. Installation and servicing should be performed only by qualified, properly trained personnel abiding by local regulations. Ensure all supplies are DE-energized before attempting connection or other procedures.
- Terminals should not be user accessible after installation and external installation provisions must be sufficient to prevent hazards under fault conditions.
- This unit is not intended to function as part of a system providing the sole means of fault protection - good engineering practice dictates that any critical function be protected by at least two independent and diverse means.
- If this equipment is used in a manner not specified by the manufacturer, protection provided by the equipment may be impaired.

Avertissement

Avertissement



Le symbole d' avertissement général attire l' attention sur les risques possibles de blessure. Respectez toutes les instructions énumérées sous le symbole pour éviter les blessures ou même la mort.

Attention



Cela signifie un risque de choc électrique et le fait de ne pas prendre les mesures de sécurité nécessaires entraînera la mort, des blessures graves ou des dommages matériels considérables.

- En fonctionnement normal, des tensions mortelles peuvent être présentes sur certaines des bornes de cet appareil. L'installation et la maintenance ne doivent être effectuées que par du personnel qualifié et dûment formé, conformément à la réglementation en vigueur. Assurez-vous que toutes les arrivées sont hors tension avant toute tentative de connexion ou autre manipulation.
- Après l'installation, les équipements ne doivent pas être accessibles à l'utilisateur et les dispositions de

protection d'installation externe doivent être suffisantes pour prévenir les risques en cas de défaillance.

- Cet appareil n'est pas conçu pour faire partie d'un système offrant l'unique moyen de protection contre les défaillances. Les bonnes pratiques d'ingénierie exigent que toute fonction critique soit protégée par au moins deux moyens divers et indépendants.
- Si cet équipement est utilisé d'une manière non spécifiée par le fabricant, la protection fournie par l'équipement peut être altérée.

Dimensions

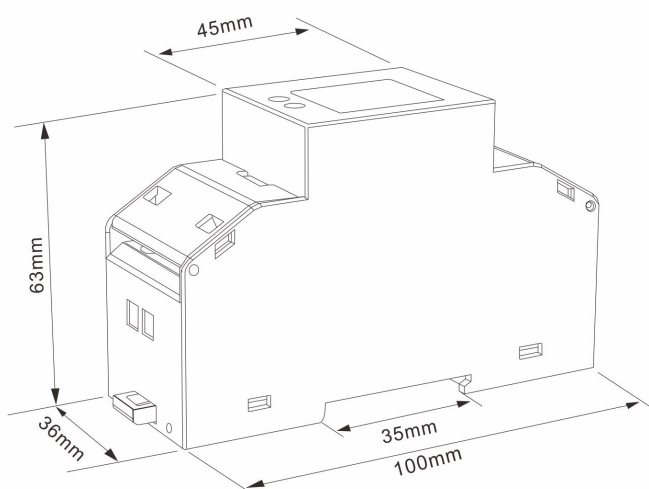

Installation

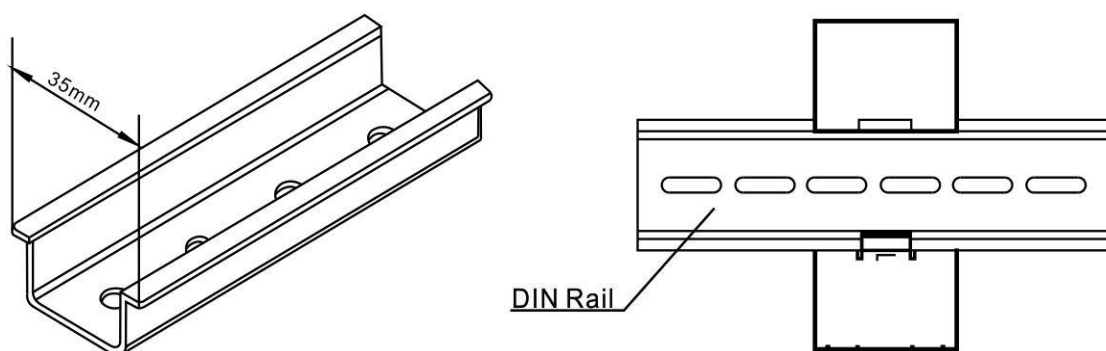

Note:

(1): The method of power demand calculation is: Import- Export. When the import and export powers appear in the demand period, the import power subtract the export power during data processing.

(2) The red marked are commonly used registers which allow users to read continuously at one time.

Holding Registers

Holding registers are used to store and display instrument configuration settings. All holding registers not listed in the table below should be considered as reserved for manufacturer use and no attempt should be made to modify their values.

The holding register parameters may be viewed or changed using the Modbus Protocol. Each parameter is held in two consecutive 4X registers. Modbus Protocol Function Code 03 is used to read the parameter and Function Code 10 is used to write. Write to only one parameter per message.

Address Register	Parameter	Modbus Protocol Start Address Hex		Valid range	Mode
		High Byte	Low Byte		
40003	Demand Period	00	02	Write demand period: 0~60 minutes, default 60. Setting the period to 0 will cause the demand to show the current parameter value, and demand max to show the maximum parameter value since last demand reset. Length : 4 byte Data Format : Float	r/w
40005	Slide time	00	04	Default 1, min. Range : 1 ~ (Demand Period -1). Length : 4 byte Data Format : Float	r/w
40013	Pulse Width	00	0C	Write pulse1 on period in Milliseconds: 60, 100 or 200, default 100. Length : 4 byte Data Format: float	r/w
40019	Network Parity and Stop	00	12	Write the network port parity/stop bits for MODBUS Protocol, where: 0 = 1 stop bit and none parity, default. 1 = 1 stop bit and even parity. 2 = 1 stop bit and odd parity. 3 = 2 stop bit and none parity. Requires a restart to become effective. Length : 4 byte Data Format : Float	r/w

40021	Modbus address	00	14	Write the Modbus address Address: 1 to 247 for MODBUS Protocol, default 1. Requires a restart to become effective. Length : 4 byte Data Format : Float	r/w
40023	Pulse constant	00	16	Options: 0 means 1000 imp/kWh 1 means 100 imp/kWh 2 means 10 imp/kWh 3 means 1 imp/kWh 4 means 10K imp/kWh Length : 4 byte Data Format: float	r/w
40025	Password	00	18	Write password for access to protected registers. Length : 4 byte Data Format : Float	ro
40029	Baud Rate	00	1C	Options: 0 means 2400 bps 1 means 4800 bps 2 means 9600 bps 3 means 19200 bps 5 means 1200 bps Default: 2 Length : 4 byte Data Format: float	r/w
40059	Auto-scroll display time	00	3A	Range: 0~60s. 0 means no scroll Default:0 Length : 4 byte Data Format : Float	r/w
40061	Backlit time	00	3C	Options:0,5,10,20,30,60 minutes 0 means the backlit always on Default: 60 Length : 4byte Data Format : Float	r/w
40087	Pulse output type	00	56	Options: 1 means Import active energy 2 means total active energy 4 means Export active energy Default: 2 Length : 4 byte Data Format: float	r/w
48193	Connection	20	00	Setting on shunt connection.	r/w

	method of shunt			Option: 00 4E means Negative type (default) 00 50 means Positive type Length: 2 byte Data Format: Hex	
461457	Reset	F0	10	00 00: Reset Maximum Demand 03: Reset Partial Energy Length : 2 byte Data Format:Hex	wo
463777	Energy Measurement model	F9	20	Options: 00 01: Total=Import 00 02: Total=Import+Export 00 03: Total=Export Length : 2 byte Data Format: Hex	r/w
464513	Serial number	FC	00	Serial number Length: 4 byte Data Format: unsigned int32 Note: Only read	ro

PART 4 Shunt



ESFL-2A Series			
Primary Input	Rated Voltage Output	Accuracy	Dimension(mm)
10-50 A	75/60/45 mV	0.5%	25x120x22
75-100 A	75/60/45 mV	0.5%	23x109x11
150-200 A	75/60/45 mV	0.5%	22x118x22
300 A	75/60/45 mV	0.5%	26x127x22
400 A	75/60/45 mV	0.5%	36x127x22
500 A	75/60/45 mV	0.5%	46x127x22
600 A	75/60/45 mV	0.5%	55x127x22
750 A	75/60/45 mV	0.5%	76x127x22

1000 A	75/60/45 mV	0.5%	96x127x22
1500 A	75/60/45 mV	0.5%	113x127x22 or 87x200x97
2000 A	75/60/45 mV	0.5%	136x200x97